

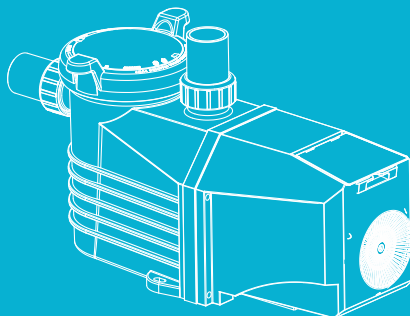

E-Turbo

VARIABLE SPEED PUMP

WITH WI-FI AND MODBUS OPTIONS



USER MANUAL



works with
Smart Life

Model: ETV Series

E-TURBO VARIABLE SPEED PUMP

FOR RESIDENTIAL POOL AND WATER FEATURES

TABLE OF CONTENT

PAGE	2 WARNINGS AND SAFETY INSTRUCTIONS
	4 1. E-TURBO PUMP OVERVIEW
	4 2. PRODUCT INFORMATION
	5 3. IMPORTANT SAFETY INSTRUCTIONS
	5 4. INSTALLATION
	11 5. CONTROL AND DISPLAY PANEL
	13 6. OPERATION PROCEDURE
	16 7. ERROR
	16 8. ROUTINE MAINTENANCE
	17 9. AFTER-SALES SERVICE
	17 10. REPLACEMENT PARTS
	17 11. TROUBLE SHOOTING
	18 12. TERMS OF THE WARRANTY

WARNINGS AND SAFETY INSTRUCTIONS

GENERAL WARNING

This instruction contain general caution information for use in Pool and SPA pump installation application. Specified Pump model function should be refer to particular manual. Components such as the filtration system, pumps and heater must be positioned so as to prevent their being used as means of access to the pool by young children.



RISK OF ELECTRICAL SHOCK

This appliance should be installed by qualified electrical personnel in accordance with National Electrical Code and all applicable local codes and ordinances. Hazardous voltage can shock, burn, and cause death or serious property damage. DO NOT use an extension cord to connect unit to electric supply to reduce the risk of electric shock.

1 The pump should be permanently connected to an individual circuit

breaker.

2 Pump must be connected to a residual current device (RCD) having a rated residual operating current not exceeding 30 mA or receptacle with ground fault circuit interrupt (GCFI).

3 . Electrical grounding must be connected before connecting to electrical power. Failure to ground all electrical equipment can cause serious or fatal electrical shock hazard.

4 Bonding: Use at least #8 AWG (#6 AWG for Canada) a solid copper conductor, run a continuous wire from external bonding lug (if available) to the pressure wire connector provided on the electrical equipment and to all metal parts of swimming pool, spa, or hot tub, and metal piping (except gas piping), and conduit within 1.5 m (5 ft) of inside walls of swimming pool, spa, or hot tub.

5 Never open the inside of the drive motor enclosure. There is a capacitor bank that holds a mains supply voltage charge even when there is no power to the unit. The voltage should be referred to the individual pump operation voltage.

6 The pump is capable of high flow rates; use caution when installing and programming to limit pumps performance only.

7 Switch OFF pump power before servicing and disconnecting the main circuit to the pump.

8 Never change the filter control valve position while the pump is running.



COMPRESS AIR HAZARDOUS

This system enclosed pre-filter / filter and become pressurized. Pressurized air can cause the Lid to separate which can result in serious injury or death.

Pool and spa circulation systems operate under high pressure. When any part of the circulating system (i.e. lock ring, pump, filter, valves, etc.) is serviced, air can enter the system and become pressurized. Filter tank Lid and pre-filter cover must be properly secured to prevent violent separation. Place pre-filter / filter air relief valve in the open position and wait for all pressure in the system to be relieved before remove the lid to access the basket for cleaning.



HYPERTHERMIA

SPA water temperature excess 38°C (104°F) may be injurious to health.

Measure water temperature before entering SPA. Hyperthermia occurs when the internal temperature of the body reaches a level several degrees above the normal body temperature of 98.6 °F (37 °C). The symptoms of hyperthermia include drowsiness, lethargy, and an increase in the internal temperature of the body.



SUCTION ENTRAPMENT HAZARD

This pump produces high levels of suction and creates a strong vacuum at the main drain at the bottom of your pool and spa. This suction is so strong that it can trap adults or children under water if they come in close proximity to a pool or spa drain or a loose or broken drain cover or grate. The Virginia Graeme Baker (VGB) Pool and Spa Safety Act creates new requirements for owners and operators of commercial swimming Pools and spas.

Commercial pools or spas constructed on or after December 19, 2008, shall utilize:

1. A multiple main drain system without isolation capability with suction outlet covers that meet ASME/ANSI A112.19.8a Suction Fittings for Use in Swimming Pools, Wading Pools, Spas, and Hot Tubs and either:
 - 1.1 A safety vacuum release system (SVRS) meeting ASME/ANSI A112.19.17 Manufactured Safety Vacuum Release systems (SVRS) For Residential and Commercial Swimming Pool, Spa, Hot Tub, and Wading Pool Suction Systems and/or ASTM F2387 Standard Specification for Manufactured Safety Vacuum Release Systems (SVRS) for Swimming pools, Spas and Hot Tubs or
 - 1.2 A properly designed and tested suction-limiting vent system or
 - 1.3 An automatic pump shut-off system.

Commercial pools and spas constructed prior to December 19, 2008, with a single submerged suction outlet shall use a suction outlet cover that meets ASME/ANSI A112.19.8a and either: 1. A SVRS meeting ASME/ANSI A112.19.17 and/or ASTM F2387, or 2. A properly designed and tested suction-limiting vent system, or 3. An automatic pump shut-off system, or 4. Disabled submerged outlets, or 5. Suction outlets shall be reconfigured into return inlets.

There are five types of suction entrapment according to The Virginia Graeme Baker (VGB) Pool and Spa Safety Act 1. Body Entrapment a section of the torso becomes entrapped 2. Limb Entrapment an arm or leg is caught by or pulled into an open drainpipe 3. Hair Entrapment or entanglement hair is pulled into and/or wrapped around the grate of the drain cover 4. Mechanical Entrapment the bather's jewelry or clothing gets caught in the drain or the grate 5. Evisceration the victim's buttocks come into contact with the pool suction outlet and he or she is disemboweled.



TO REDUCE ENTRAPMENT HAZARD RISK



Two function suction outlets per pump must be installed to prevent entrapment. The minimum separate of suction on the same plate must be at least point to point measurement 1 meter (3ft) apart. It is used to avoid "dual blockage" by bather. If suction is found damage, broken, cracked, missing or not securely attached during regular checking, shunt down the pool and replace it immediately. A vacuum release or vent system is recommended to install for suction entrapment release.

1. E-TURBO PUMP OVERVIEW

The Emaux E-Turbo variable speed pump is a cutting-edge product that combines efficiency and reliability. It features a unique back cover design that reduces noise, increases durability and prevents electric shocks. It also has a superior cooling system that extends the life of the pump and ensures optimal performance in challenging conditions. The removable panel offers easy installation and access to controls, making maintenance and adjustments simple and convenient. The membrane keypad has large keys that are easy to find and press accurately.

2. PRODUCT INFORMATION

PRODUCT DIMENSIONS

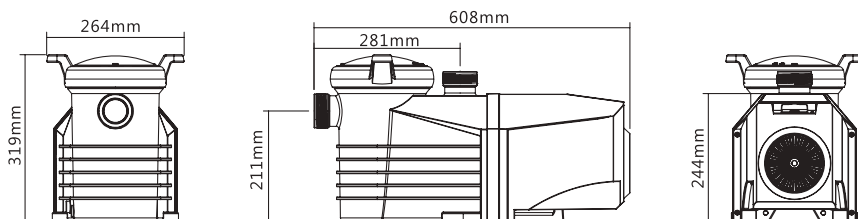

Code	Model	Power	Connection Size	Weight (kg)	Input Power (kW)	House Power	RPM
9020401	ETV125	115/230V,50/60Hz	1.5" ID / 50mm ID 2" OD / 63mm OD	17.6	1.1	1.25hp	800-3400
9020402	ETV165	115/230V,50/60Hz	1.5" ID / 50mm ID 2" OD / 63mm OD	17.6	1.5	1.65hp	800-3400

TECHNICAL INFORMATION

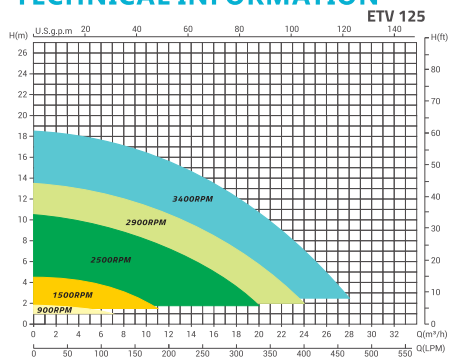

Model: ETV 125

RPM	900 RPM	1500 RPM	2500 RPM	2900 RPM
Power Input (W)	40	120	450	650
Current (amp)	0.25	0.5	1.8	2.8
Flow Rate (m ³ /h)	5.0	9.0	15.0	18.0

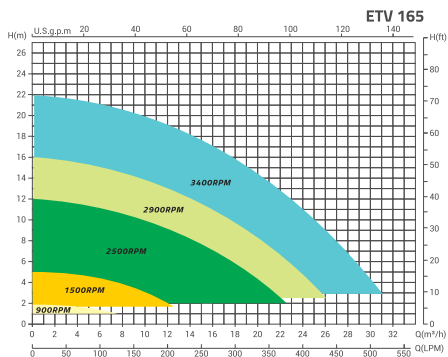

Model: ETV 165

RPM	900 RPM	1500 RPM	2500 RPM	2900 RPM
Power Input (W)	50	150	585	850
Current (amp)	0.3	0.65	2.5	3.8
Flow Rate (m ³ /h)	6.0	10.0	18.0	20.0

3. IMPORTANT SAFETY INSTRUCTIONS



IMPORTANT: The instruction manual you are holding includes essential information on the safety measures for installation and start-up of this equipment. Therefore, the installer as well as the user must read the instructions before beginning installation and start-up. Keep this manual for future reference.

1. A protective device is to be installed in the fixed wiring.
2. This appliance cannot be used by children (8 years or below). Children shall not play with the appliance. Cleaning and user maintenance shall not be made by children without supervision.
3. This appliance cannot be used by persons with reduced physical, sensory or mental capabilities, or lack of experience and knowledge, unless they have been given supervision or instruction concerning the use of the appliance by a person responsible for their safety.
4. The appliance shall be installed in accordance with national wiring regulations and a means of disconnection must be incorporated in the fixed wiring in accordance with the wiring rules. A disconnected system must be incorporated in the fixed.
5. The pump is to be supplied through a residual current device (RCD) or Ground Fault Circuit Interrupt (GFCI) having a rated residual operation current not exceeding 30mA.

Correct disposal of this product	
	This symbol on the product, or in its packaging, indicates that this product may not be treated as household waste. Instead, it should be taken to the appropriate waste collection point for the recycling of electrical and electronic equipment. By ensuring this product is disposed of correctly, you will help prevent potential negative consequences for the environment and human health, which could otherwise be caused by the inappropriate waste handling of this product. For more detailed information about the recycling of this product, please contact your local council, your household waste disposal service, or the shop where you purchased the product.

4. INSTALLATION

1. Install the pump as close to the pool as possible, preferably in a dry, well ventilated area away from direct sunlight. Protect the pump from excessive moisture.
2. Place the pump as close to the water source as possible, so that the suction pipe is short, straight and direct to reduce the friction loss. Don't install the pump at more than 10ft (3 meters) of geometrical height from water level. Pump priming time for 3m (10ft) should be at least 7 minutes at 2900 RPM.
3. Before installing the pump, make sure that the surface is solid, elevated, rigid and vibration free.
4. Secure the pump to the base with screws or bolts to limit the vibration and the stress on the pipe or the joints.
5. Leave enough space for gate valves in suction and discharge piping, if required.
6. Connect the suction and discharge pipe to the outlet and inlet of the swimming pool.
7. Make sure that floor drainage is adequate to prevent flooding.
8. Make sure that the pump and piping are accessible for servicing.

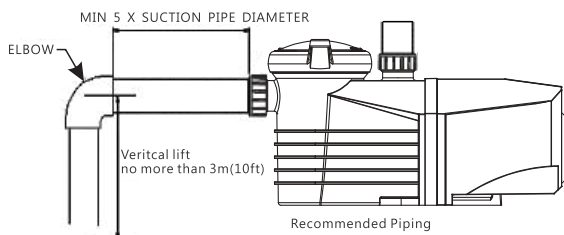

Base

ETV pair with dedicated base can easily replace several other pumps: Silen ESPA®, Astralpool® Victoria plus silent® or SENA® .

The base increase the height of the suction side of the pump.

Base Configuration	Suction Height (mm)	Pump Height (mm)
Without base	210	286
With base, side AV	225	301
With base, side ES	246	322

Contact dealer to order the ETV base (code 4201210356) .

Note:

The pump suction and discharge connections have thread stops, DO NOT try to screw the pipe beyond these stops.

The two sets 2" union adaptor are universal design for metric and imperial PVC pipe connection.

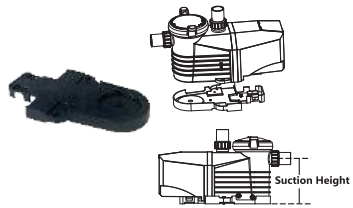

4.1 ELECTRICAL WIRING

For wiring sizes and general guidelines for proper electrical installation, please follow the specifications defined in the National Electric Code and any local codes as required.

We supply versions with standard cable with plug for your local code or without cable. Please contact your local distributor for technical and order inquiries.

- Check system voltage matches operating voltage on the rating plate of the pump
- Disconnect power to the pump.
- Open the top cover of the motor.
- Connect Earth ground to screw labelled  .



4.2 RS-485 CONNECTION

The RS-485 Connection point is located on the side of the variable speed drive and should be connected to the MODBUS controller by a cable connector assembly (only the connector without cable is provided) as in the figure below.

Making the RS-485 cable connector assembly:

Disassemble the female connector and locate the pin numbers on the base. Prepare one Pair 22 unshielded twisted Paired Cable RS 485. The length depends on the PUMP distance from the MODBUS controller which should not be more than 100m. Solder pin 1 for A and pin 2 for B respectively which corresponds to the Pump MOSBUS controller RS485 output pin configuration. Reassemble the connector and plug into the RS485 socket on the variable speed pump.



4.3 START UP



- Verify the pump shaft turns freely.
- Check that the mains voltage, current and frequency correspond with the name plate.
- Never let the pump run dry! Running a pump dry may cause damage the mechanical seal causing leakage and flooding.
- Fill the pre-filter with water before starting the motor.
- Before removing the pre-filter lid, STOP PUMP, CLOSE GATE VALVES in suction and discharge pipes.
- Always STOP THE PUMP before when RELEASING ALL PRESSURE from the pump and the piping system.
- Never tighten or loosen screw while the pump is in operating.
- The suction pipe and the suction inlet in the pool must be free from obstruction.

WARNING: Tighten / untighten the pump Lid by hand only

4.4 PRIMING PUMP

1. Switch off the pump
 2. Close all valves in suction and discharge pipes.
 3. Release air pressure from filter and piping system (from filter air relief valve).
 4. Remove the pump lid and fill the pump strainer pot with water.
 5. Replacing and tighten the lid (ensure the lid O-ring is properly placed)
 6. Open the filter air relief valve, Open all valves and the pump unions are tight.
 7. Turn the pump power on. The pump will start priming.
 8. When water comes out of the air relief valve on the filter, close the air relief valve. The pump has primed.
- Remark: Priming which can take up to fourteen (14) minutes at 10ft (3m) vertical life of 1.5" inlet piping. Priming will depend on vertical length of suction lift and horizontal length of suction pipe. If the pump does not prime within 14 minutes, stop the pump and check for a suction leak. Then, repeat procedure 1-7.

4.5 Mobile App : Smart Life

Smart Life app allows users to control ETV pumps outside the home network through their mobile phones. Please follow the instructions below to complete the Smart Life App installation, and set up and operate the ETV water pump.

4.5.1 App installation

Search "Smart Life – Smart Living" in Google Play Store(Android) or AppStore (Apple iOS) to download the App for your mobile phone

Android (PlayStore)	iOS (AppStore)
	

4.5.2 App setup

Check this link for more information about the Smart Life app that including installation the app, account management, scene function, manage homes and more.

<https://developer.tuya.com/en/docs/iot/user-manual-for-tuya-smart-v3177?id=K9obrofrfk4sk> or you can scan this QR code to visit the web site.



Scan this QR code to visit Tuya Technical Support site

Complete the following steps based on Tuya Technical support site.

- 1) Download and install the Smart Life app on the mobile phone
- 2) Register the account for Smart Life app, you can enter a mobile phone number or email address, agree on the **User Agreement, Privacy Policy, and Third Party Information Sharing List**, and then tap **Get Verification Code**.
- 3) Enter the returned verification code to navigate to the password setting page. Set a password as required and tap **Done**.

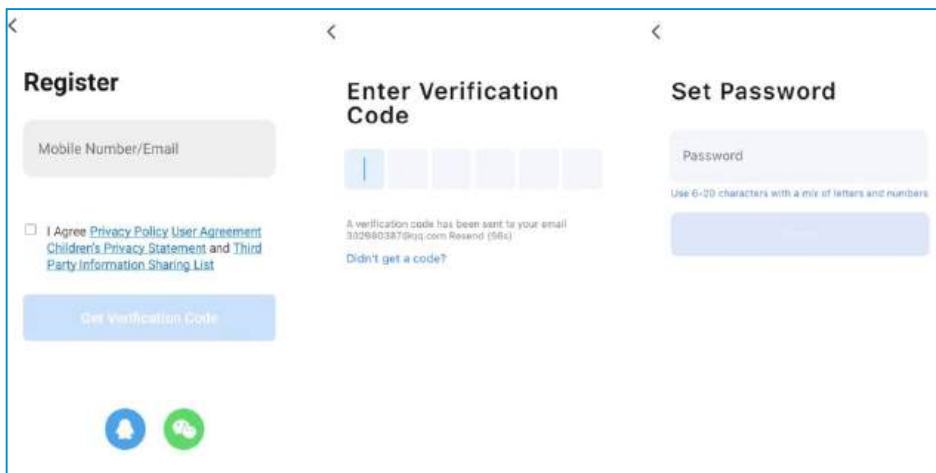













- 4) Open the app. If you have registered an account of the app, tap Log In to go to the login page.
- 5) Enter the registered mobile phone number or email address and the password and tap Log In.

After the Smart Life app is installed and registered the account in your mobile phone, we can start connect the pump to Wi-Fi network.

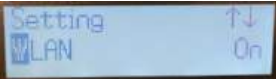
4.5.3 Connect your ETV to your Wi-Fi network

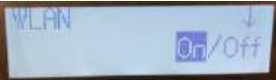
Remark: The connected router must have internet access.

Step	Operation Description	Screenshot (for completed steps)
1	Make sure the pump is in off mode LED is OFF 	
2	Press 「Menu」 on the LCD panel to enter main menu 	
3	Press 「Menu」 again to enter setting menu 	

4	<p>Press 「Down」 key several times until "WLAN" display, and then press 「Menu」 to enter WLAN menu</p> 	
5	<p>Press 「Up」 or 「Down」 to select "ON" option Press 「Menu」 to enable WLAN function</p> 	 <p>The above example expresses "ON" is selected⁷</p>
6	<p>Press 「Up」 or 「Down」 to select "Yes" option, Then 「Menu」 to reset the WLAN</p> 	
7	<p>After the WLAN is reset in success, the network configuration mode is triggered.</p>	

Note: Press 「Esc」 each time in the menu to return to the previous menu until the home page

4.5.4 Open the Smart Life App and click "Add device" in the app

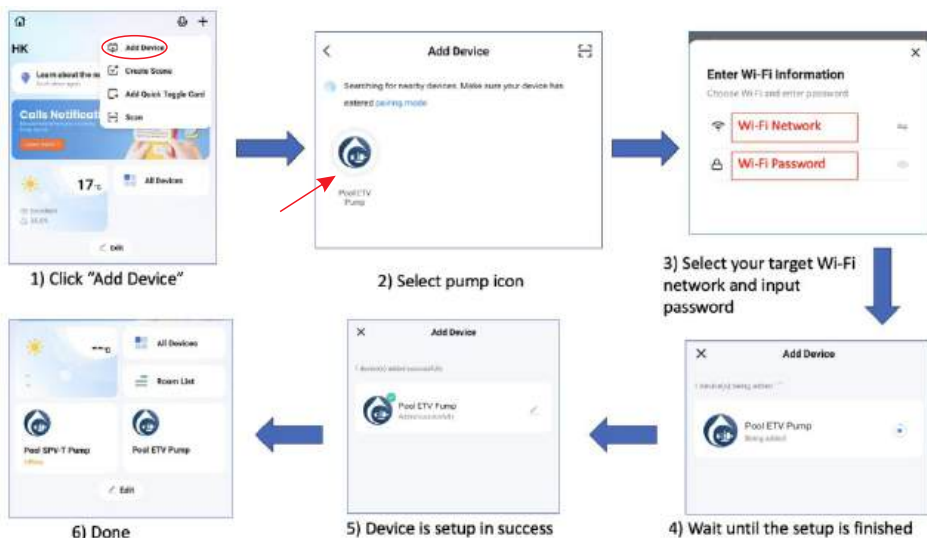

4.5.5 User interface

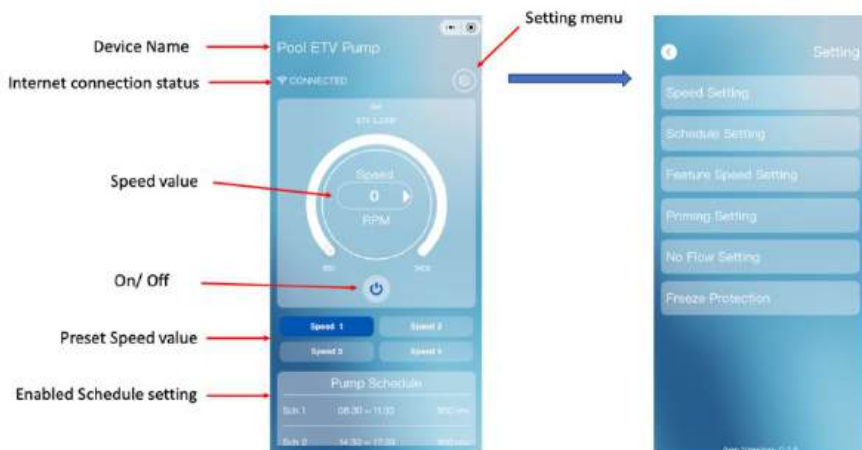

4.5.6 Remote control and Real-Time Data Updates

User can control their ETV pump out of their Wi-Fi homework, allowing users to manage pumps anytime, anywhere. Regardless of operations between the mobile app and the pump, the status will be synchronized instantly.



5. CONTROL AND DISPLAY PANEL

5.1 OVERVIEW

The pump can be controlled and programmed from the key panel. Key features are:

1. Clock: Real time clock display
2. Running Status: Running speed and power rating display.
3. Pre-set Speed: 4 pre-set running speeds.
4. Function settings: Real-time clock, 3 pre-set speeds, 2 schedules, No flow and self-priming.
5. Error display: Overcurrent, overvoltage, under-voltage, overheating fault code.
6. Auto-recovery: The auto-recovery feature will restore the setting as before the error (e.g. overcurrent, overvoltage, under-voltage, overheating or power failure)
7. Power failure recovery: If the power is interrupted, the pump will be restored as before when the power resume.
8. Wi-Fi: Wi-Fi ready indication after start up.
9. RS485 Connection: external automation control over MODBUS.

5.2 CONTROLLER



5.3 PROGRAM FLOW CHART

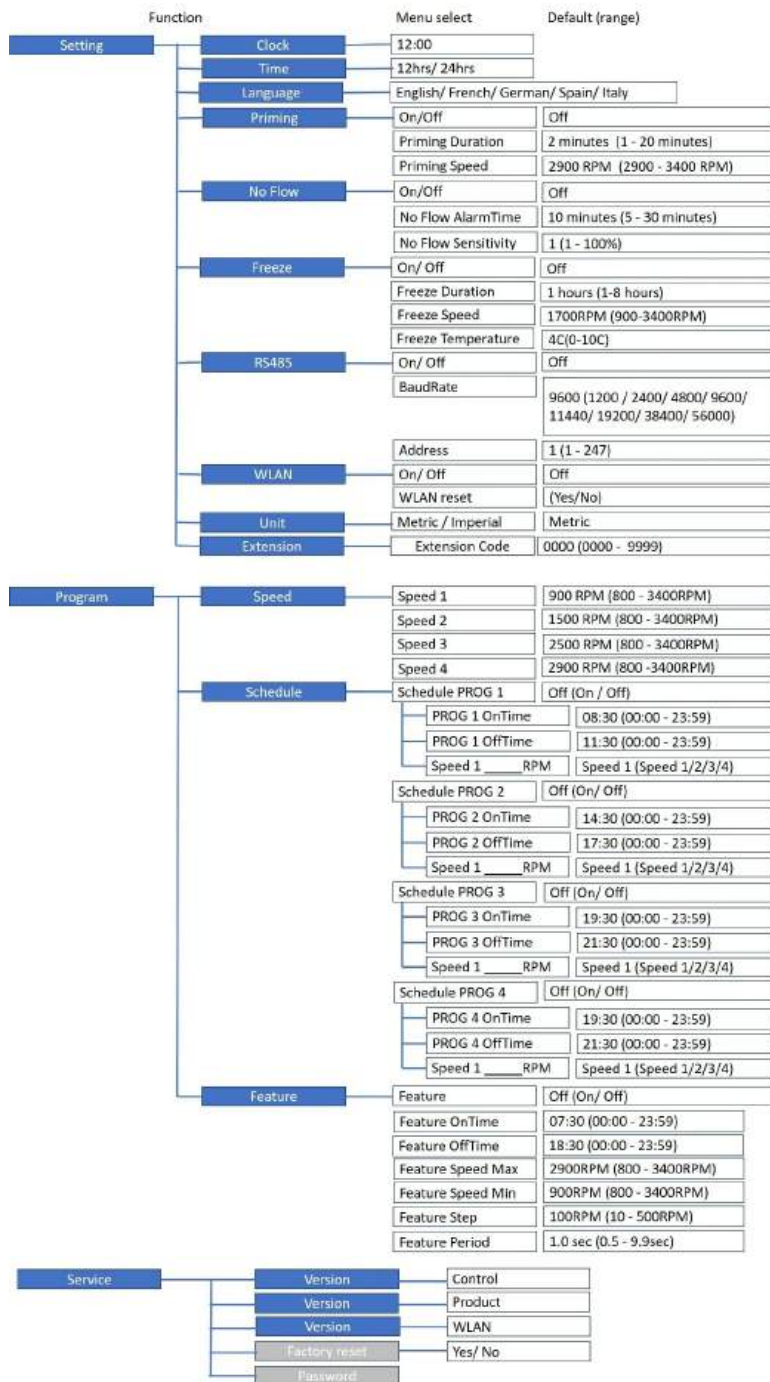

5.4 Mode selection



Setting:

General setting for the pump, which includes time, language, priming, protection setup, etc.

In setting mode, "Setting" is shown on the screen and you can press ▲ or ▼ enter select different features.

Press Menu to enter or Esc to escape.



Program: For the pump programming setup, you can program the pump speed and schedule in this menu.

In program mode, "Program" is shown on screen and you can press ▲ or ▼ select different program settings. Press Menu to enter or Esc to escape.

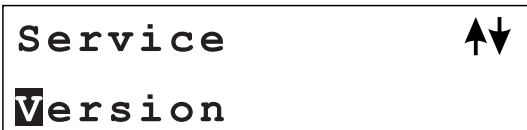

Service:

This menu shows the pump information and factory reset features.

In Service mode, "Service" is shown on the screen and you can press ▲ or ▼ enter select different service settings.

Press Menu to enter or Esc to escape.

6. OPERATION PROCEDURE

6.1.1 POWER UP



During power up: time, pump status, speed setting will be displayed on the screen.

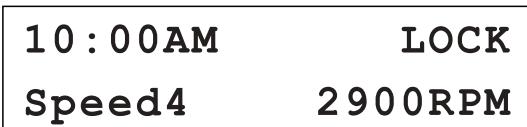

Press ▲ or ▼ to activate/ deactivate key lock function.

6.2 Settings

Clock

Time - Change the time by pressing ▲ or ▼ . Then press "Menu" to save/ "Esc" to cancel

Language

Language - Change display language to English, French, German, Spain or Italy. Press "Menu" to save/ "Esc" to cancel.

Priming

Priming is the process of running the pump and generating suction in the pump, pipe, and filter to push pool water circulation. The priming function is to run the pump at a speed higher to generate higher suction in the system to improve the priming process.

During the pump starts to run 1) the Priming function is enabled, and 2) the priming speed is higher than the pump preset speed, the pump will run priming according to the priming feature preset.

- On/off – activate/ deactivate the function
- Duration – priming time
- Speed – priming speed
- Press ▲ or ▼. Then press “Menu” to save/ “Esc” to cancel.

No-Flow

No flow is detected if the circulation is blocked, even though the pump is running, and no water flows in the pipe through the pump. Loading conditions may be under maximum continuously. This is a protection if the flow is blocked for a time range, stop the pump.

- On/off – activate/ deactivate the function
- Duration – activated time (pump stop)
- No Flow Sensibility – setting the sensibility (from 1% to 100%) for the function
- Press ▲ or ▼. Then press “Menu” to save/ “Esc” to cancel.

Freeze

Freeze protection is a function during low temperatures before freezing, keep water in the piping running to prevent freeze. Water freezing in the pipe will destroy the pipe and cause leakage.

- On/off – activate/ deactivate the function
- Duration – activated time (pump run)
- Temperature – activated temperature for the feature.
- Press ▲ or ▼. Then press “Menu” to save/ “Esc” to cancel.

RS485

The pump is equipped with an RS485 communication interface for an external automation controller. It is not for domestic user access purposes. It is an always-ready interface for external automation control.

The pin assignment is 1 = A and 2 = B. The waterproof connector type is SP1310 4pins. ETV's RS485 is pure data communication without 5V power supply output.

Contact your dealer for the MODBUS programming manual, if you are a system integrator.

Wi-Fi

The pump can be connected to your mobile device over the Internet, which is outside your home network.

You can download the Apps “Smart Life” from the Apps Store or Google Play. Follow the on-screen instructions (start at page 7) to set up and operate the pump over the internet.



- IEEE802.11, 2.4GHz, b/g/n
- Internal antenna, open area 50m
- Data throughput 300Mbits

Unit

The display can be changing unit between metric or imperial.

- Press ▲ or ▼. Then press “Menu” to save/ “Esc” to cancel.

Extension

This is to enable extra functions (0000-9999). Input code 1234 to enable SVRS function. Input other code to disable SVRS function.

- Press ▲ or ▼. Then press “Menu” to save/ “Esc” to cancel.

After enable SVRS, the function will be added into the menu.

Setting	SVRS	SVRS Enable	Off (On / Off)
		SVRS Alarm Time	1 sec (1-10)
		SVRS Sensitivity	1% (1-100)
		SVRS AutoReset	On (On / Off)
		SVRS ResetTime	60 sec (30-999)
		SVRS ResetSpeed	900 RPM (800-3400)

6.3 Program

Speed

You can program a speed into S1, S2, S3 or S4. Press to run the pump at preset speed (S1, S2, S3 or S4) and the LED indicated to the speed key will turn on.

- Press ▲ or ▼. Then press "Menu" to save/ "Esc" to cancel

Schedule

The schedule is a timer and speed program feature for the pump. When the schedule function is set, the pump will start and stop to run according to the setting. There are a total of four programmable speeds with four programmed timers that can be programmed by the user. 4 schedules can be programmed by the user.

- On/off – activate/ deactivate the function
- OnTime—Scheduled time to turn on the pump.
- OffTime – Scheduled time to turn off the pump.
- Speed – pump speed scheduled.
- Press▲ or ▼. Then press "Menu" to save/ "Esc" to cancel.

Schedule Policy

- Programmed Schedule Priority Schedule 1 > Schedule 2 > Schedule 3 > Schedule 4.
- If more than 1 schedule is enabled within the same period, the controller will operate only with the highest priority schedule and speed. The corresponding indication light will turn on.
- If all schedules are completed according to their pre-set times, the controller will return to the condition before setting the schedule.
- When one of the programmed schedules is running and before the schedule ends. Any operation such as Start / Stop, speed adjustment by "▲" or "▼", S1-S4, and any change by external RS485 MODUS. The schedule timer and speed will be resumed when it is started over by pressing the Start / Stop to run again.
- The scheduled settings and auto-recovery cannot contradict each other. When there is an error, the variable speed driver will restore the settings to those before the error. (The priority setting is still applicable).

Feature

Variable speed can adjust their performance to accommodate changes in system requirements, such as varying flow rates or pressure needs. This flexibility makes them suitable for a wide range of applications.

- On/off – activate/ deactivate the function
- OnTime—Scheduled time to turn on the pump.
- OffTime – Scheduled time to turn off the pump.
- Speed Max - Max pump speed scheduled.
- Speed Min - Min pump speed scheduled.
- Step – value of every step of increase / decrease speed.
- Period – Period of every increase / decrease step.

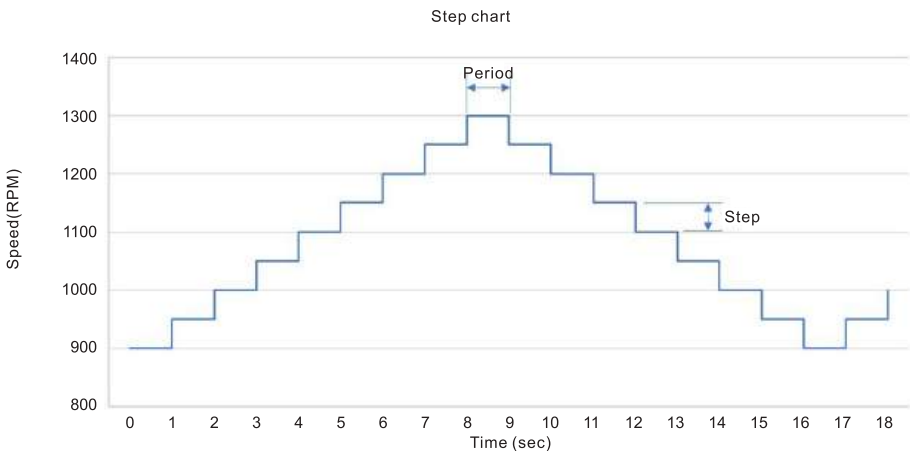

Table 1 Example: Speed Max=1300RPM, Speed Min=900RPM, Step=100RPM, Period=1.0s

6.4 Service

Versions

It is the pump internal version reference which includes control, product and Wi-fi.

Factory reset

The feature will reset the pump to factory default. (refer to Program flow chart). All setting in the pump will be clear.

7. ERROR

When pump detects functional failure, it will stop and display Error code on the control panel. All LEDs on panel will be blinking.

ERRORS DESCRIPTION

7.1 OPERATION ERRORS

When the pump is not working, an error code will be shown on the controller display. E.g. "OV". Press the "Start/Stop" button to restore the controller.

The common error codes are the following:

Error	Description	Reason
OC	Overcurrent: driver current output exceeds the threshold.	- Driver output failure. - Driver IPM module is damaged.
OV	Overvoltage: the main circuit DC voltage exceeds the threshold.	- Exceeded power from the power supply. - Power supply voltage exceeds the control settings.
UV	Under-voltage: the main electric current is too low.	- Ambient temperature is too high. - Supply voltage fluctuation is too large.
OH	Overheating: the motor heat sink is overheated.	- Ambient temperature is too high. - Motor Cooling Fan does not work.
NF	No Flow: No water Flow is detected.	- The Mechanical seal might damage if no water flow.
SVRS	Safety Vacuum Release System.	- To prevent entrapment or injury in swimming pools.
LR	Lock Rotor: A locked rotor condition occurs when the motor's rotor.	- The motor is stock.

When error is found, check the error source refer to "Reason", fix it and run manual reset by press "Start/Stop" button, or run power up reset by disconnect the power and wait for at least 60 seconds. If the error continues, contact your Emaux technical service.

8. ROUTINE MAINTENANCE

The only routine maintenance needed is the inspection/cleaning of the trap basket. Debris or trash collected in the basket will choke off the water flow through the pump. Follow the instructions below in order to clean the trap:

1. Stop the pump, close the gate valve in suction and discharge, and release all pressure from the system before proceeding.
2. Unscrew the trap lid (turn counter clockwise).
3. Remove the strainer basket and clean. Make sure all the holes in the basket are clear, flush the basket with water and replace it in the trap with large opening at the pipe connection port (between ribs provided). If the basket is replaced backwards, the cover will not fit on the trap body.
4. Clean and inspect the lid ring; reinstall on the trap cover.
5. Clean the ring groove on the trap body and replace the lid. To help keep the lid from sticking, tighten it by hand only.
6. Prime the pump (see priming instructions above).

9. AFTER-SALES SERVICE

Refer all service needs to your local agent or dealer as his knowledge of your equipment makes him the best qualified source of information. Order all the repair parts through your dealer. Give the following information when ordering repair parts.

1. Unit name on the plate data or serial number on the label.
2. Description of the part.

10. REPLACEMENT PARTS

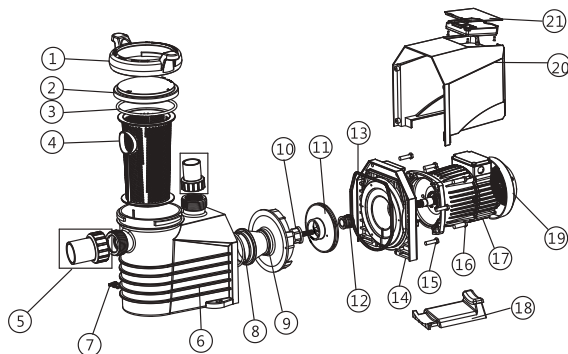

Key No.	Part No.	Description	QTY	Key No.	Part No.	Description	QTY
1	4204010050	Nut For Lid	1	12	E020001	3/4" Mechanical seal	1
2	4203810050	Transparent Lid	1	13	111990019	O-Ring for Flange	1
3	111010057	O-Ring For Lid	1	14	4202010050	Flange	1
4	4202310050	Basket	1	15	112000069	M8*35 Screw	6
5	E023801	1.5" Union	2	16	112000065	M8*25 Screw	4
6	4200510050	Pump body	1	17	420591410195	TYC-48S(1.25HP)Motor	1
7	89021307	Drain Plug With O-ring	2	17	420591410196	TYC-48M(1.65HP)Motor	1
8	111002592	O-Ring For Diffuser	1	18	4201210050	Base	1
9	420219954	Diffuser	1	19	4201710050	Fan Cover	1
10	89020719	Screw for impeller with O-ring	1	20	4201510050	Motor Cover	1
11	01311057	ETV125 impeller	1	21	E020401	Programmable Controller	1
11	01311058	ETV165 impeller	1	21	5100610051	Lid for Programmable Controller	1

11. TROUBLE SHOOTING

Problem description	Possible causes
Motor does not start	<ol style="list-style-type: none"> 1. Disconnect switch or circuit breaker in off position 2. Fuses blow nor thermal over load open 3. Locked motor shaft 4. Motor windings burned out 5. Defective starting switch inside single phase motor 6. Disconnected or defective wiring 7. Low voltage

Pump does not reach full speed	<ol style="list-style-type: none"> 1. Low voltage 2. Pump connected to the wrong voltage
Motor over heats (protect or trips)	<ol style="list-style-type: none"> 1. Low voltage 2. Motor windings connected to the wrong voltage on dual voltage model
Pump delivers no water	<ol style="list-style-type: none"> 1. Pump is not primed 2. Closed valve in suction or discharge line 3. Leakage or air into suction system 4. Impeller clogged
Leakage of water at the shaft	Shaft seal requires replacement
Low pump capacity	<ol style="list-style-type: none"> 1. Valve in the suction or discharge line partly closed 2. Suction or discharge line partly plugged 3. Suction or discharge line too small 4. Plugged basket in skimmer or hair and lint strainer 5. Dirty filter 6. Impeller clogged
High pump pressure	<ol style="list-style-type: none"> 1. Discharge valve or inlet fittings closed too much 2. Return lines too small 3. Dirty filters
Noisy pump and motor	<ol style="list-style-type: none"> 1. Plugged basket in skimmer or hair in lint strainer 2. Worn motor bearings 3. Valve in suction line partly closed 4. Suction line partly plugged 5. Vacuum hose plugged or too small 6. Pump not supported properly
Air bubbles at inlet fittings	<ol style="list-style-type: none"> 1. Leakage of air into the suction line in connections or valve stem 2. Cover gasket of hair and lint strainer needs cleaning 3. Low water level in the pool

Note: If the above recommendations of this manual do not solve your particular problem(s), please contact your local service agent for further assistance

12. TERMS OF THE WARRANTY

As original purchaser of this equipment have purchased from Emaux Water Technology Co Ltd, through Authorized International Distributor or Dealer, warrants its products free from defects in materials and workmanship under normal use during warranty period. The warranty period begins on the day of purchase and extends only to the original purchaser. It is not transferable to anyone who subsequently purchases the product from you. It excludes all expendable parts. During the warranty period, Emaux authorized reseller will repair or replace defective parts with new parts or, at the option of Emaux, serviceable used parts that are equivalent or superior to new parts in performance.

This Limited Warranty extends only to products purchased from Emaux authorized reseller. Does not extend to any product that has been damaged or rendered defective.

- (a) as a result of accident, misuse or abuse;
- (b) as a result of natural disaster;
- (c) by operation outside the usage parameters stated herein;
- (d) by the use of parts not manufactured or sold by Emaux;
- (e) by modification of the product;
- (f) as a result of war or terrorist attack; or
- (g) as a result of service by anyone other than Emaux authorized reseller or authorized agent.

EXCEPT AS EXPRESSLY NO OTHER WARRANTIES EXPRESSED OR IMPLIED, INCLUDING ANY IMPLIED WARRANTIES OR MERCHANTABILITY AND FITNESS FOR A PARTICULAR PURPOSE. EMAUX EXPRESSLY DISCLAIMS ALL WARRANTIES NOT STATED IN THIS LIMITED WARRANTY. ANY IMPLIED WARRANTIES THAT MAY BE IMPOSED BY LAW ARE LIMITED TO THE TERMS OF THIS EXPRESS LIMITED WARRANTY.

EMAUX WATER TECHNOLOGY CO., LTD

**ADDRESS: 2/F, Lockhart Centre, No. 301-307 Lockhart Road,
Wanchai, Hong Kong**

PHONE +852 2832 98

 **YOUR PREMIER SUPPLIER**

www.emauxgroup.com