

Dolphin skimmi™ 200 | 300

User Manual

Dolphin Skimmi™ Robotic Pool Skimmer

EN

User Instructions

You will enjoy the time and money you'll now save cleaning your pool with your new Dolphin Skimmi™ autonomous, solar powered robotic pool skimmer. It cleans the entire water surface, including debris on the walls.

Using Dolphin Skimmi™ is super easy and efficient. Just turn it ON, place Dolphin Skimmi™ in the water, and start it with the app or turn ON Auto-Start. Cable-free and no need to charge the battery. As autonomous as can be, Dolphin Skimmi™ avoids hoses, obstacles, and traps, charges intelligently with the sun, and it saves enough energy to work at night for your morning swim. Dolphin Skimmi™ saves you tons of time with the net, energy on the pump, and it only requires occasional quick rinsing of the filter tray and solar panel.

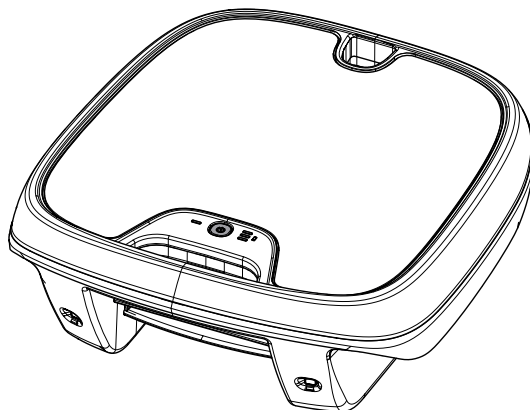

EN

Dolphin Skimmi™ Robotic Pool Skimmer

User Instructions

Contents

[READ AND FOLLOW ALL INSTRUCTIONS](#)

[Maytronics One™ APP INSTRUCTIONS](#)

[Settings](#)

[Profile](#)

[Battery Recommendations](#)

[Quick Start Guide](#)

[Feature Descriptions](#)

[Water Resistance – IP-X7](#)

[LED Indicators](#)

[Off-Season Storage](#)

[Troubleshooting](#)

[DIY Repairs](#)

READ AND FOLLOW ALL INSTRUCTIONS

WARNINGS:

- 1. To avoid injuries or being startled in the water** due to an unexpected collision with the robot, do not swim while the robot is in the water.
- 2. Overheating** - Do not store the robot and its battery in a hot location, such as a car.
- 3. Service by a certified technician only.** This product contains Li-ion battery pack. Do not attempt to open or replace the battery as this may damage the battery which can cause an explosion, battery chemical leak, corrosion, swelling, and explosion due to water entering the battery.
- 4.** This appliance is not intended for use by persons, including children, with reduced physical, sensory or mental capabilities, or lack of experience and knowledge, unless they have been given supervision or instruction concerning use of the appliance by a person responsible for their safety. Children should be supervised to ensure that they do not play with the appliance.
- 5. Charger** - Use **only** the Maytronics charger model SEC1241300C supplied with the product.  The charger is for indoor use only. Do not use an extension cord to connect the charger to the outlet; provide a properly located indoor outlet. The charger is intended for charging the robot which contains a 2.45Ah Li-ion battery pack
- 6. Warning:** Do not recharge non-rechargeable batteries.
For USA/Canada The power supply must be connected only to a supply circuit that is protected by a ground fault circuit interrupter (GFCI). This GFCI should be tested on a routine basis. To test the GFCI, push the test button. The GFCI should interrupt power. Push the reset button. Power should be restored. If the GFCI fails to operate in this manner, the GFCI is defective. If the GFCI interrupts power to the power supply without the test button being pushed, a ground current may be flowing, indicating the possibility of an electric shock. Do not use the power supply. Disconnect the power supply and contact the manufacturer for assistance.
Outside USA/Canada Use only with a power circuit protected by an RCD (residual current device) having a rated residual operating current not exceeding 30mA.

CAUTIONS:

1. If damaged - Do not use the robot in case of mechanical damage to the robot or battery. Take it to an authorized Maytronics technician.

2. Repairs by an unauthorized person voids warranty - Do not attempt to open and repair the robot beyond instructions given in the quick guide and user manual. Any repairs done by a nonauthorized technician can damage the product and would void the warranty.

3. Do not push the robot underwater. It is waterproof, but not designed to withstand the water pressure if submerged. Water entering the robot could corrode and damage the internal parts.

4. It should be recycled at certified electronics battery recyclers that accept batteries.

Batteries should not be discarded in the trash or put into municipal recycling bins.

Do not disassemble the battery.

5. When you need to dispose of your faulty robot, please follow your local region's instructions.

Maytronics Ltd. declares that the radio transceiver model is in compliance with Directive 2014/53/EU and all other relevant EU regulations. The full text of the EU Declaration of Conformity is available by contacting wecare@maytronics.com

ENVIRONMENTAL INFORMATION

Processing of electrical and electronic equipment after their period of use (Only applicable in the E.U.). Our goods are designed and manufactured using top quality materials and components, which are environmentally-friendly and which can be reused and recycled.

This symbol, marked on the equipment or packaging, means that this equipment can not be processed as normal domestic waste. You should hand it in to the technician who installs the new equipment or at special collection points for electric and electronic equipment. Recycling this equipment does not cost you anything and by separating it from other waste you are helping to prevent negative consequences for the environment and for people's health by avoiding incorrect handling. Help us to preserve the Environment. Thank you.

For detailed information on how to correctly dismantle this equipment for recycling, please contact the nearest Dolphin dealer or search for an authorized distributor in Maytronics web site www.maytronics.com.

Use the Dolphin Skimmi™ in the following water conditions only:

- Temperature 5°C - 40°C / 41°F - 104°F
- NaCl Maximum = 6000 PPM

Unit protection: IP X7

Radio transmitter: Bluetooth® Frequency range: 2402-2480 MHz

Transmitted power: 0.002W

The Lithium-Ion battery in this product is non-replaceable. It should be recycled at certified battery electronics recyclers that accept batteries. Batteries should NOT be discarded in the trash or put in municipal recycling bins. Do not disassemble the battery.



SAVE THESE INSTRUCTIONS

Maytronics One™ APP INSTRUCTIONS

Pairing with your phone

1. Ensure Bluetooth® is enabled on your smartphone.
2. Download the app from the App Store or Google Play.
3. Press and hold the power button on the Dolphin Skimmi™ for 3 seconds to start pairing.
4. Start the app, sign up, and enter the validation code that is sent to your email.
5. Follow instructions in the app to connect via Bluetooth®.



Start the robot

1. Tap "Clean" on the app home screen. Its default program will clean your pool, save energy for night work, and ensure optimal battery care.
2. When swimming, you can turn the robot off and put it in the sun or connect it to the external charger to charge the battery.
3. You can change the default settings to fit your pool type or bathing habits in the "Mode" menu.
4. Pickup feature (specific models): If your app shows the Pickup button, tap it when you want to remove the robot. It will spin in the pool until you tap the next button to indicate your location, then it will come to you. If you prefer, you can use the Manual Drive to bring the Dolphin Skimmi™ to the edge of the pool for pickup.

Warranty

In the app home screen, tap the 3 dots at the top of the screen for settings. Select "Warranty" and follow the instructions to register your warranty.



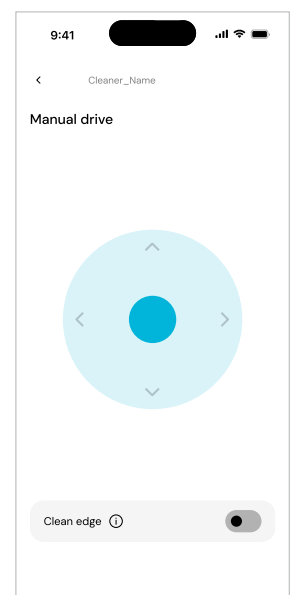

Manual/remote control

1. Tap "Manual Drive" to see the manual control interface.
2. Toggle "Clean Edge" if you want the robot to splash water on walls to remove debris when near them.
3. Navigate using the dark blue circle in the light blue circle. If you lift your finger from the circle, the robot will soon stop.



Robot status and indications

The robot has various sensors and indicators in the app to help you properly set it and to know that everything is working as expected.

1.  The battery indicator shows how much energy the battery has stored. If the battery level is low, Dolphin Skimmi™ hibernates to preserve battery life. If it is between 25-100, it works as usual. When it is full, the charge from the solar panel bypasses the battery and powers the motors directly without finding direct sunlight and stopping for Smart Solar Recharge breaks. This is done to preserve battery life so it can work for longer.
2.  The Bluetooth® icon shows the strength of the connection.
3.  The charging/lightning bolt shows how many watts the sun is currently charging the robot.
4.  The temperature indicator shows the water temperature.
5. The robot status line describes what the robot is doing or if there is an error that needs to be taken care of, such as something stuck in one of the wheels.

SETTINGS

CLEANING MODES

- **Eco** - Auto-scheduled cleaning and break/solar-recharge sessions. Adjust the settings to workload and available sun. Long sessions (90min) are for full-sun and pools that get lots of debris quickly. Medium sessions (45 min) are for partial shade and pools that get average amounts of debris. Short sessions (20) are for low-sun conditions and pools that remain relatively clean. If you turn the robot OFF, you need to turn it ON again. At any time, if the battery charge is low, the robot will be on standby until the battery receives enough energy to work. The LED blinks every 6 seconds when on standby.
- **Edge-free** - Doesn't invest time cleaning the edges.
- **Edge** - Only cleans the edges.
- **Leaves Capture** - Uses sensors to prioritize large leaves and other floating debris.

PROFILE

Name and email

Update your name and email, if needed. This is the email where customer support will contact if you ask for help.

APP PREFERENCES

Measuring units - select metric or imperial (USA) units

Language - select your preferred language

POOL DETAILS

Select the shape, approximate size, and features of your pool.

BATTERY RECOMMENDATIONS

- **Set and forget:** In most situations, you don't need to do anything to charge Dolphin Skimmi™. Just leave it in the water and the robot charges itself whenever the sun is out. If left to its default work/rest schedule, the charge is usually sufficient for daytime and nighttime work.
- **If there is no direct sunlight in the pool** you can remove the robot and plug in the charger or place it in a sunny location for it to charge. Note that placing it on hot pavement can damage the battery – place Dolphin Skimmi™ on the lawn or yard furniture. To prevent debris from hardening and clogging the filter, be sure to rinse the filter tray before placing it in a dry, sunny area outside of the pool.
- **If there are low-sunlight conditions** like cloudy seasons or high latitudes, and the battery frequently runs low, you can go into the cleaning modes menu, select "Eco", and select shorter sessions (20 or 45 minutes depending on sun conditions). Shorter sessions means the robot will take more breaks to recharge. This will save battery for night work before the morning swim and will give it more time to charge in the morning before it starts to work.
- **Preserving the battery:** Be sure that the robot is not left in a very hot location (such as a car or hot pavement) as this will likely damage the battery and void the warranty. The default settings are programmed for maximal battery life.
- **Cleaning the solar panel:** Periodically clean dust and pollen off the solar panel surface gently to maximize charging efficiency. Use a soft towel or sponge with soap for any accumulated sunscreen. If limescale develops, you can clean it with vinegar and a soft towel.
- **Smart Solar Recharge** is ON when using the Eco cleaning mode. It automatically takes breaks in sunny spots to recharge the battery.

QUICK START GUIDE

Getting started

1. Scan the QR code to download the app.
2. Register for the warranty.
The serial number is under the robot, on the inside of the floats.



- 2 Insert the filter tray until it **clicks into place**.

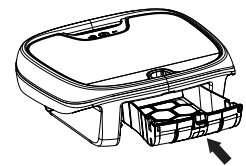

- 3 1. Install the phone app Maytronics One™ from the App store or Google Play.
2. Start the app and connect.

- 4 1. To pair, make sure your phone Bluetooth™ is ON.
2. Press and hold the power button on the robot until the blue light blinks.
3. Follow instructions on your phone to finish the process.
4. Once paired, the robot's light will remain solid blue whenever it's connected to your phone.

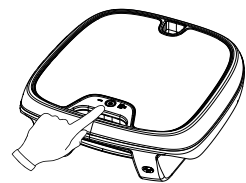

Start via the power button or app

Start with app

Download, pair, and start the Dolphin Skimmi™ via the app.

Power button on the robot

Press the power button and place the robot in the water.

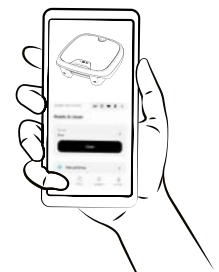

Let it swim

Place the Dolphin Skimmi™ in a sunny pool.

No need to control, charge, or remove it, except to rinse the filter tray when it is full.

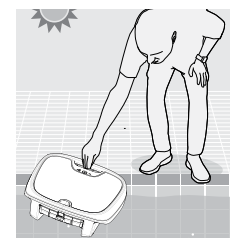

Autonomous Mode:

The default Eco Mode automatically cleans the entire surface, including walls.

Dolphin Skimmi™ takes breaks in the sun to ensure the battery is as full as possible.

Manual Drive:

The app has a Manual Drive remote control interface for spot cleaning and for fun. Dolphin Skimmi™ autonomous default settings cover the whole pool surface, including the edges. Open the settings in the app for more cleaning mode options.

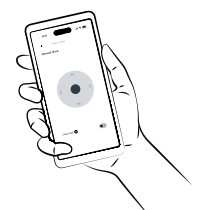

QUICK START GUIDE

Features and options

Charging

If the robot doesn't get enough sunlight to charge autonomously, you can use the Maytronics wall charger. The wall charger is for indoor use.

To connect the charger: Open the charging seal under the robot and plug the charger into the port. Make sure to close the seal before placing back into the pool.

Cleaning the Robot

Note: Be sure to clean the filter tray before it dries out to prevent debris from sticking to the filter.

Rinse filter tray

1

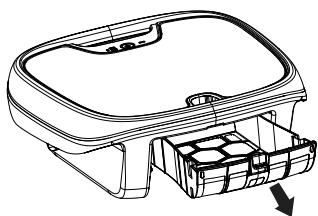

Press the tab on the filter tray to release and remove it.

2

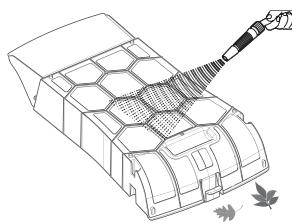

Use a low-pressure hose to gently wash debris from both sides.

Clean solar panel

Rinse dust off with water and your hand.

For oily grime (sunscreen, etc...), use a gentle sponge or rag with soap and water.

Note: Abrasive scrubbing could scratch the solar panel.

FEATURE DESCRIPTIONS

- **Manual Drive** - Control the robot's movement with the app's Remote Control interface.
- **Smart Solar Recharge** - Maximizes solar charging by taking breaks in sunny spots.
- **Avoids Obstacles** - Sensors and algorithms enable Dolphin Skimmi™ to run autonomously without getting frequently stuck.
- **Various Cleaning Modes** -
 - Regular "Eco" Mode is full coverage
 - "Edge-free" water coverage without time spent on walls
 - "Leaves Capture" uses sensors to focus on large debris
 - "Edge" only focuses on the pool walls where debris ends up (Dolphin Skimmi™ 300 only).
- **External Charger** - Remove robot and charge with a cable during low-sunlight conditions. Make sure to close the seal before placing the robot in the water.



WATER RESISTANCE - IP-X7

IP-X7 - While Dolphin Skimmi™ is able to handle being submerged for up to 1m (3ft) for short periods, we recommend not submerging it or washing it with a high-powered water stream because if you accidentally go beyond the resistance that it's designed for, water can get in and cause corrosion.

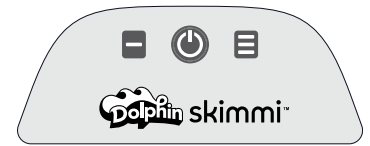
LED INDICATORS









LED Indicators

		Meaning
Blinks blue		Pairing mode – turn on app and connect
Solid blue		Connected to a phone – start robot, check status, manual drive, adjust settings
	Solid	Working autonomously (robot is ON)
	Blinks	Blinks occasionally when taking a break in Eco Mode
Blinks red		Error - Connect to app for details
	Blinks	Rapid blinking indicates the battery level while charging via cable

OFF-SEASON STORAGE

1. Recommended storage temperature range: -20°C - 40°C / -4°F - 104°F. Storing the robot in a colder or hotter location could damage the battery.
2. To prevent draining the battery while in storage, ensure the robot is turned OFF.
3. Make sure there is no water left in the robot.

TROUBLESHOOTING

Symptom	Possible reason	Corrective action
Robot can't be switched ON. Green pause  LED is not lit or blinking	<ul style="list-style-type: none"> Battery is not charged. 	<ul style="list-style-type: none"> Charge the robot - Plug the charger into the port under the robot or place the robot in direct sunlight.
Robot doesn't start cleaning. Battery indication is low or OFF. App says battery is low.	<ul style="list-style-type: none"> Battery is too low. 	<ul style="list-style-type: none"> Plug the external charger into the port under the robot or place the robot in direct sunlight and let the battery recharge.
Robot does not move.	<ul style="list-style-type: none"> Cleaning has not started (green indication  LED constantly ON). Robot is on a pause between cleanings (green pause  LED single-blinks every 6 seconds). Battery is low (green  LED blinks. New app update failed (green pause  LED is constantly blinking). 	<ul style="list-style-type: none"> Open the app and tap the Start button. Wait until the next cleaning cycle starts if the status bar in the app shows that it is in a recharge pause. Connect the cable to the port under the robot or wait for the battery to charge in the sun. Open the app and complete the robot's software update.
Robot has stopped moving, it gives a red error signal  .	<ul style="list-style-type: none"> There is an object stuck in one of the wheels of the robot. 	<ul style="list-style-type: none"> Remove the object or hair. If it's the front wheel, you can remove and clean it. If it still doesn't work, contact Customer Care: wecare@maytronics.com
Robot often stands still, the cleaning time has been significantly reduced.	<ul style="list-style-type: none"> Cloudy skies, low sunny intensity for a long time. Decreased battery capacity. 	<ul style="list-style-type: none"> Tap the cleaning mode box in the app home screen, select the short sessions option. Or, charge the robot with the cable. Contact Customer Care to replace the battery: wecare@maytronics.com
Robot turns only in circles.	<ul style="list-style-type: none"> Sensor covers are dirty. Salt in the pool is not perfectly dissolved, the water is polluted. Water's gotten into the robot. 	<ul style="list-style-type: none"> Wipe off dirt with a damp cloth. Open the app and select a lower water quality in the "Smart Detect" function or turn the function OFF. Contact Customer Care: wecare@maytronics.com
Robot does not collect debris in the filter tray, it pushes small objects in front of it.	<ul style="list-style-type: none"> Non-return flap is stuck or has been incorrectly installed. Filter tray is full. 	<ul style="list-style-type: none"> Check if the non-return flap of the filter tray is connected properly. See the illustration below. Empty the filter tray and wash it with a stream of water.
A paddle wheel often jams when moving. Red  alert indicator.	<ul style="list-style-type: none"> Hair or another object is wrapped around the shaft, reducing the strength of the wheel. Filter tray is full. Low strength of motors. 	<ul style="list-style-type: none"> Remove unwanted hair or other object. Empty the filter tray and rinse it.
When moving, the front of the robot dives more, the collection wheel makes a "slapping" sound.	<ul style="list-style-type: none"> Filter tray is full. The robot is pulled by a strong stream of water from the filter pump, or a strong wind is blowing. The non-return flap is stuck or has been incorrectly installed. Water's gotten into the robot. 	<ul style="list-style-type: none"> Empty the filter tray and rinse it. Short-term instability. This will fix itself when the abnormal situation changes. Check if the non-return flap of the filter tray is connected properly. See the illustration below. Contact Customer Care: wecare@maytronics.com
APP cannot find or connect to the robot.	<ul style="list-style-type: none"> Robot is turned OFF. Battery is not charged. Large distance or obstacles between the smartphone and the robot. Robot is currently connected to another smartphone. 	<ul style="list-style-type: none"> Press the power button until the light turns on. Connect to the external charger. Move your smartphone closer to the robot. Robot can only be connected to one smartphone at a time. Close the app of the other smartphone.
Solar panel is covered by plaque (limescale).	<ul style="list-style-type: none"> Your local water has a high level of calcium (hardwater). Calcium is deposited on surfaces and accumulates into plaque. 	<ul style="list-style-type: none"> Clean gently with lemon juice or diluted citric acid or vinegar. Prevent future buildup by rinsing less frequently or towel drying. Also, you can balance your pool's pH with a water test strip and adding pool-grade acid accordingly.

DIY Repairs

Replacing the non-return flap if it comes off the filter tray.

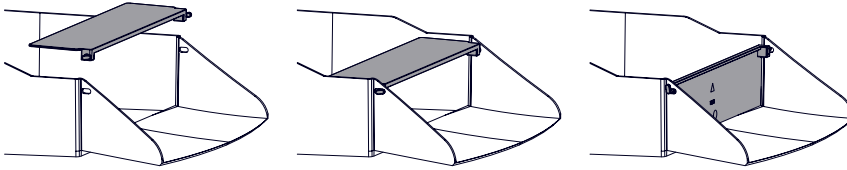

Replacing the filter

Note: You can choose between a 4 or 6 liter filter and purchase them on the Maytronics website or the store where you bought Dolphin Skimmi™.

Remove the old filter and insert the new one exactly as you do after rinsing it.

Removing hair and debris from the front wheel

1. Remove the filter tray and disconnect the front wheel from the bearings on its sides.
Note that the bearings and wheel are not symmetrical. There is a static and a dynamic bearing.
2. Remove any hair or debris from the bearings and wheel.
3. Attach the bearings.
4. Attach the wheel back onto the bearings. Follow the illustration:

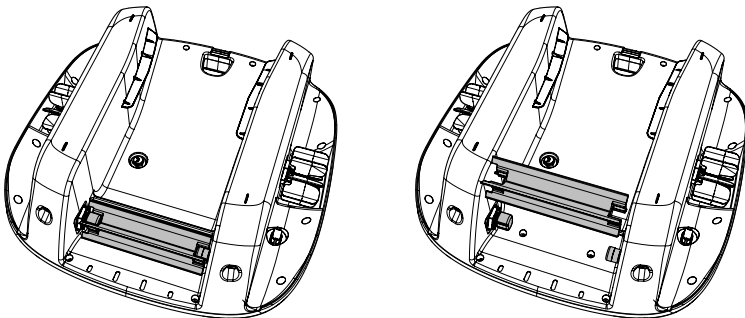

If these solutions do not solve your problem, contact Maytronics Customer Care:

North America

1-888-365-7446 ext. 1002 | customersupport@maytronicsus.com

France

+33 (0)4 42 98 14 90 | support@maytronics.fr

Australia, NZ, South Africa

1 300 693 657 | infoau@maytronics.com

Rest of the world / Maytronics HQ

00 800 69694141 (toll free number)

00 972 77 96 14 204 (international call)

wecare@maytronics.com

For full information and additional troubleshooting please visit us at: www.maytronics.com