



SUPERIOR ENERGY EFFICIENCY

FOR RESIDENTIAL POOL AND
WATER FEATURES



Variable Speed Pump

INNOVATIVE AND HIGH PERFORMANCE

The Emaux E-Turbo variable speed pump is a cutting-edge product that combines efficiency and reliability. It features a unique back cover design that reduces noise, increases durability and prevents electric shocks. It also has a superior cooling system that extends the life of the pump and ensures optimal performance in challenging conditions. The removable panel offers easy installation and access to controls, making maintenance and adjustments simple and convenient. The membrane keypad has large keys that are easy to find and press accurately.



E-TURBO
PUMP
Variable Speed Pump



Special Design for Strainer Basket

Robust Structure Design:

Resistant to suction pressure and damage. It is made of durable materials that can handle the tough chemicals and water conditions that are common in pool systems, delivering consistent and reliable performance for a long time.

Basket:

Enlarged 3-Litre Strainer

Close Bottom Basket:

The enclosed bottom basket allows to capture of small heavy waste which condenses at the bottom.

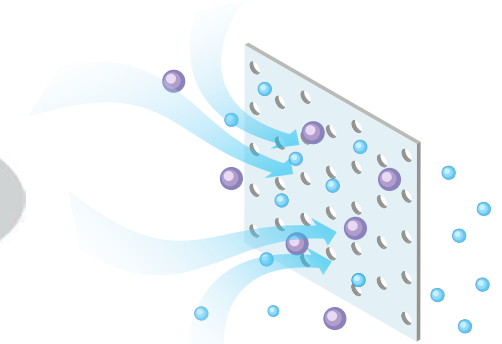

Special Hole Design:

Ensures optimal water flow and debris filtration. The holes are uniformly sized at 3mm, which allows water to pass through smoothly while trapping larger debris.

Bonus filter bag:

Protect the pump with a bonus nylon filter bag. This accessory can catch hair, fine leaves and other small debris that could damage the impellor. By using the filter bag, you can extend the lifespan of your pump and keep it running smoothly.

Special Design for PMM Motor

Motor Advantages

The PMSM motor has an integrated PCB design, reducing the motor size by 20%. This allows the pump to achieve a streamlined and concise design. The motor has a high efficiency of up to 86%, surpassing industry standards. The rotor is specially designed (Patent) and processed to not only improve the reliability, but also enhance its stability, ensuring quiet and smooth operation.

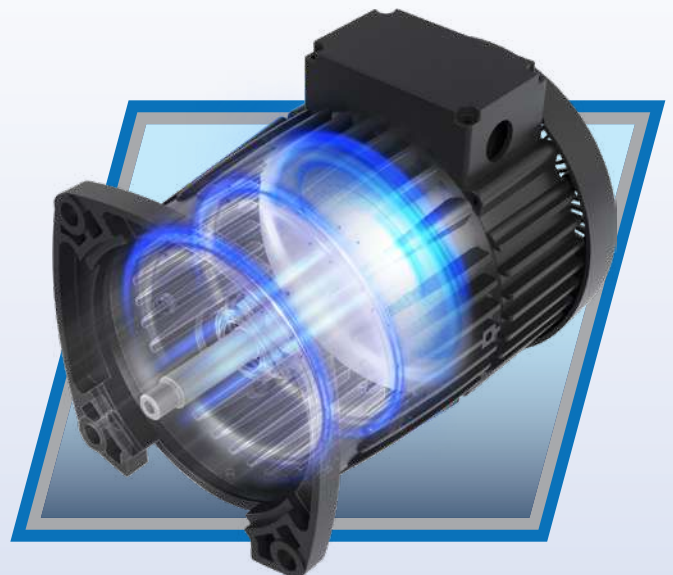

PHYSICAL STRUCTRE

Transparent Lid

Allows quick inspection, saving time and effort.

Ring Lock

Design for easy Maintenance.

Union Connections

1.5" ID / 50mm ID,
2.0" OD / 63mm OD

Basket

Enlarged 3-Litre Strainer

Pump Body

Glass Filled Acrylonitrile
Butadiene Styrene

Diffuser

Made of glass filled polycarbonate

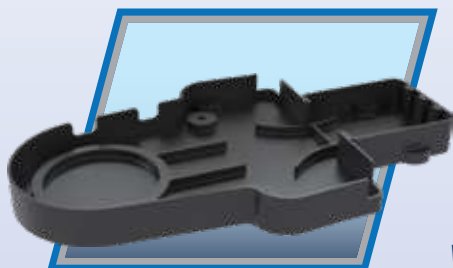

Retro-Fit Replacement

Precise alignment with plumbing position, making it easy to replace **Astralpool SENA**.

With Adjustable base: **ESPA Silen & Astralpool Victoria Plus**.



Air Ventilation

The motor has fins extending out from the engine to pull heat away. Cool air is then forced over the fins. The back cover formed a ventilation path around the motor to keep air flowing to the hottest areas. Improve Cooling efficiency.

Innovative Addition Back Cover

- Noise reduction: help dampen the noise generated by motor.
- Corrosion Protection: resistance to corrosion compared to metal casing.
- Electric leakage prevention: provide an additional layer of isolation, reducing the chances of electric leakage from the motor.

Detachable Smart Control Panel

Operate by Variable Speed Driver easy removal and reattachment, providing flexibility and portability.

Motor

- Permanent Magnet Motor (PPM)
- Totally Enclosed Fan Cooled (TEFC)
- Aluminium Motor Casting
- 800 RPM - 3400 RPM
- Voltage: 115V / 230V

Shaft Seal

- Carbon rotating face
- SiC Stationary face
- Stainless Steel 316 spring
- EPDM Bellows

Impeller

Made of glass filled polycarbonate

New Connectivity and External Smart Control

DOWNLOAD THE APP SMART LIFE

NEW



IoT Connection:

An IoT version can be controlled and monitored over an internet connection, enabling users to manage pool functions remotely. This connectivity allows for real-time adjustments, automated scheduling, and enhanced efficiency in maintaining optimal water quality.

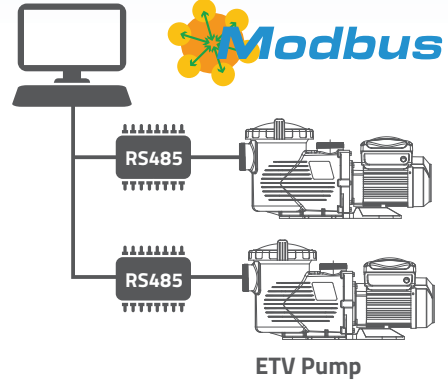

DETACHABLE PANEL ALLOW WALL MOUNTING



DETACHABLE SMART CONTROL PANEL

- LCD with backlight offers good visibility even in low-light conditions.
- Simple and clear indication on the screen.
- User- friendly interface.
- Large key membrane provides good tic tac feeling, easy to press.

Product Dimensions

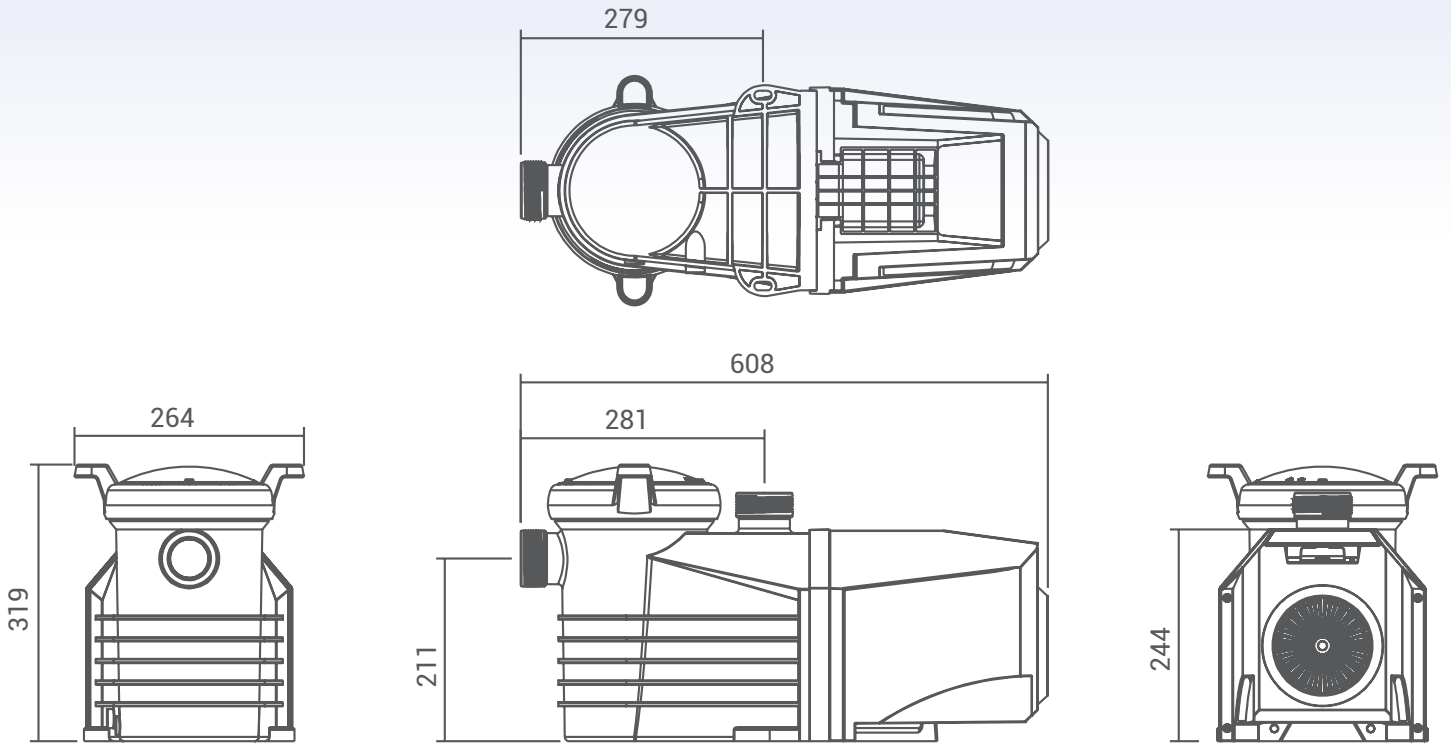

Technical Information

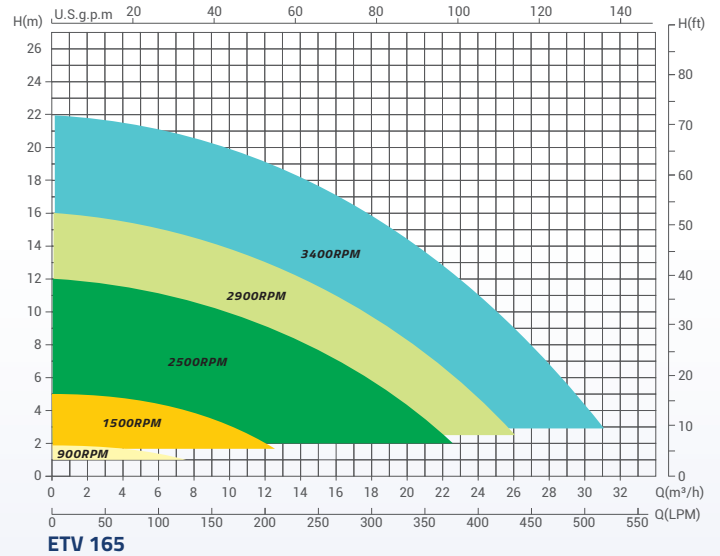
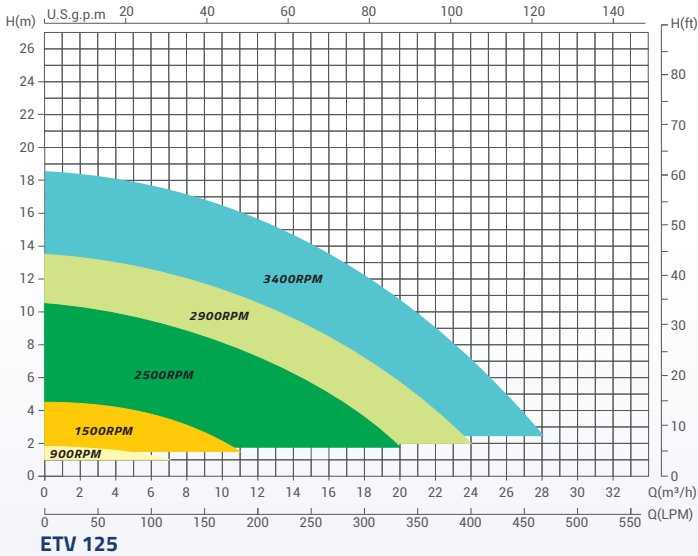

Model: ETV 125

RPM	900 RPM	1500 RPM	2500 RPM	2900 RPM
Power Input (w)	40	110	410	610
Current (amp)	0.3	0.5	0.8	2.6
Flow Rate (m³ / h)	4.9	11.2	19.8	23.1
Flow Rate (LPM)	81.66	186.6	330.5	385.8
Efficiency (Liters per watt)	122.5	101.8	48.3	37.9

Model: ETV 165

RPM	900 RPM	1500 RPM	2500 RPM	2900 RPM
Power Input (w)	50	130	505	850
Current (amp)	0.3	0.6	2.2	3.8
Flow Rate (m³ / h)	6	12.4	22	25
Flow Rate (LPM)	101.1	206.6	367.5	416.6
Efficiency (Liters per watt)	121.4	95.3	43.6	29.4

Code	Model	Power	Connection size	Weight	Input Power	Horsepower	RPM
9020401	ETV 125	115 / 230V, 50 / 60 Hz	1.5"ID / 50mm ID, 2.0" OD / 63mm OD	20 Kg	1.1 kW	1.25 hp	800-3400
9020402	ETV 165	115 / 230V, 50 / 60 Hz	1.5"ID / 50mm ID, 2.0" OD / 63mm OD	20 Kg	1.5 kW	1.65 hp	800-3400



EMAUX WATER TECHNOLOGY CO., LTD

**ADDRESS: 2/F, Lockhart Centre, No. 301-307 Lockhart Road,
Wanchai, Hong Kong**

PHONE +852 2832 9880

www.emauxgroup.com

💧 YOUR PREMIER SUPPLIER